

Art Series
A204 | A404 | Ax400
Owners Manual

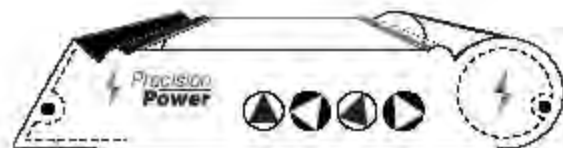

 **PrecisionPower.**
7402 W Detroit St. Suite 180
Chandler, AZ USA
1-800-62-POWER

 **PrecisionPower.**
Absolutely State of the Art



CONGRATULATIONS AND THANK YOU for your choice of a PrecisionPower, Inc. high performance mobile audio amplifier. PrecisionPower is proud to be a world leader specializing in the design, engineering, and manufacture of "State of the Art" mobile audio electronics. Our success is derived from the fact that we do not incorporate gadgets or passing fads into our products. Sound engineering practice, combined with deceptively simple yet highly effective circuit designs, characterize every **PPI** product. Yet, our demand for maximum value dictates that every ounce of fat be trimmed if it does not contribute to sound quality or reliability. This is why **PPI** products have consistently enjoyed an unparalleled reputation for sound value. We are sure that your new Art Series amplifier will provide you the "State of the Art" in mobile audio amplification.

Important Safeguards

The following list of 'Important Safeguards has been compiled to help you achieve optimum satisfaction and the highest quality performance from your new mobile audio amplifier. Please take the time to review these safeguards before operation and or installation of your new Art Series amplifier.

Read Instructions

We all have a tendency to read instructions only after something doesn't work as anticipated. This manual provides specific information concerning the operation and installation of your new amplifier. Please read this manual thoroughly and retain it for future reference.

Keep Your Sales Receipt

Your **PPI** amplifier has a three-year limited warranty when it is installed by an Authorized **PPI** dealer. Non-Authorized dealer installed (**PPI**) amplifiers carry a one-year parts / ninety days labor limited warranty. To establish the starting date of warranty coverage, a copy of your sales receipt must accompany your amplifier for all warranty service. Please file your sales receipt away for future reference. For your convenience, a complete limited warranty statement is located at the back of this manual.

Follow Instructions

All use and installation instructions should be followed to assure proper operation of your new Art Series amplifier.

Heed All Wiring Requirements

A high-performance amplifier requires minimum wire gauges be used for the Power, Ground, Remote Turn-On, and Speaker cables. To assure proper operation of your Art Series amplifier, following all wiring requirements.

Heed all Fusing Requirements

The fusing requirements of your Art Series amplifier have been established for its continued safe operation. Replacement with a higher value fuse may result in damage and voiding of warranty.

Installation Accessories

The Art Series amplifiers will require non-supplied installation accessories. Please refer to the Installation Section of this manual for a list of requirements or consult your Authorized **PPI** dealer before installation.

Water and Moisture

Never mount your Art Series amplifier in a location which would subject it to immersion or exposure to water.

Servicing

Do not attempt to service this amplifier yourself. Opening or removing covers will void your warranty. For service information, consult your Authorized **PPI** dealer or call Precision**Power**, Inc. at 1-800-62-POWER. Our customer service representatives are available Monday through Friday from 8am to 5pm Mountain Standard Time.

Caution!

The use of a high-powered audio system may cause hearing loss or damage. While PPI systems are capable of "Concert level" volumes with incredible accuracy, they are designed for you to enjoy the subtleties created by musicians while listening at reasonable sound pressure levels. The use of a high powered audio system may impair your ability to hear traffic sounds, and therefore, may constitute a traffic hazard. We advise lower volume levels while driving.

Table of Contents

Glossary of Terms	4
Features	5
Specifications	6
About Your Art Series Amplifier	7
Installation	11
System Tuning	15
Troubleshooting	17
System Designs	18
Limited Warranty	20

Glossary

The following terms are used in this manual. Since they may be unfamiliar, the following definitions are provided.

AM II	Adaptive MOSFET II is an advanced protection circuit designed to prevent amplifier shut-off due to low load impedance. AM II optimizes output power to maintain uninterrupted operation whenever the amplifier senses a load impedance of less than two Ohms. An L. E. D. signals when AM II is working,
Bridging:	Combining two amplifier channels into one channel, typically used to create a mono output.
Gain:	The ratio of output voltage to input voltage. The gain control allows adjustment to the amplifier's output level for varying input levels.
L.E.D.:	Light Emitting Diode. Indicates power on / off and when AM II is working.
Load Impedance:	Measurement of speaker(s) resistance / reactance that the amplifier must drive.
Mixed Mono:	The amplifier's ability to play the Left and Right Stereo channels while playing a third (bridged) mono channel.
PWM	Pulse-Width Modulated power supply. Our PWM maintains a regulated output voltage and a high conversion efficiency over the input supply range of 11 - 15 VDC. The result is less demand on the battery, lower (amplifier) operating temperature, and extremely accurate low frequency reproduction.
Remote Turn-On:	Low current automatic switching circuit that turns the amplifier on and off. Typically connected to the remote antenna or amp turn-on lead of most car radios, cassette, or CD players.

Features A204 | A404 | Ax400

Pulse-Width Modulated (PWM) Switching Power Supply for High-Efficiency

Regulated Power Supply Provides Full Rated Power from 11-15 VDC

Discrete Power Amp Circuitry

Internally Bridgeable

Mixed Stereo / Mono Operation

Output Short Circuit Protection

Low Impedance Protection with Diagnostic L.E.D.

Adjustable Input Sensitivity

2 Gold RCA and DIN Input Connectors

PPI's Exclusive Wire Connection System

Three Year Limited Warranty

Manufactured in the U.S.A.

Ax400 (only)

Integrated Two-Way Electronic Crossover with 4 Selectable Frequency

Integrated Crossover Features 18 dB per Octave Slopes

Four Modes of Operation

Low-Pass Outputs for Easy System Expansion

2 Gold RCA Outputs

Technical Specifications

Art Series Model:	A204	A404	Ax400
Continuous Power Output: (Front/Rear Output - Watts per Channel)			
4 Ohms, 11-15 VDC, Stereo:	25 Watts	50 Watts	50 Watts
2 Ohms, 11-15 VDC, Stereo:	50 Watts	100 Watts	100 Watts
4 Ohms, 11-15 VDC, Bridged:	100 Watts	200 Watts	200 Watts
Power Fuse:	20 Amp	30 Amp	30 Amp
Crossover Slope:	N/A	N/A	18dB / Octave
Crossover Frequencies:	N/A	N/A	10, 110, 260, 300 Hz
Dimensions (inches):	2x9.25x10"	2x9.25x13"	2x9.25x15"
Shipping Weight:	7.5 lbs	8.5 lbs.	10 lbs.

Common Specifications:

Power Bandwidth:	10 Hz -50 kHz
Total Harmonic Distortion:	.02%
Input Sensitivity:	.2 - 2.5 V
Input Impedance:	10k Ohms
Load Impedance (Stereo):	2 - 8 Ohms
Load Impedance (Bridged):	4 - 8 Ohms
Supply Voltage:	11 - 15 Volts

About your New Art Series Amplifier

As a world leader in the design and manufacture of high-performance mobile amplifiers, Precision**Power**, Inc.'s commitment to being: "Absolutely Start of the Art" demands that we create products that offer high reliability and superior sound quality. To do this, we must recognize and find solutions to the unique problems, which affect the performance of electronics in the mobile environment.

At **PPI**, we build upon experience. We currently design and manufacture over 20 different amplifiers. Each is designed to be application specific, either in rated power, number of channels, or with integrated accessories. This large reservoir of knowledge has provided us with the innovative design solutions incorporated in the Art Series Amplifiers.

As you review this section, keep in mind that the new features found in the Art Series amplifiers directly influence their performance and, therefore, must be understood before operation and / or installation. Please take a few minutes to review the following information. The user benefit and operational parameters of the 'key' design features are detailed below.

Pulse- Width Modulated (PWM) Switching Power Supply

The voltage supplied by an automobile's electrical system will vary depending upon the number of accessories you are using. As you turn on / off various accessories (head-lights, air conditioner, rear window defroster, power windows, etc) the voltage that your car's electrical system is providing will change according to the demand. The Art Series fully regulated power supply guarantees rated spec over a wide range of voltages (11 VDC to 15 VDC).

Our PWM supply offers high-efficiency. This efficiency translates into cooler operation. The hostile environment of mobile audio presents a real problem for an amplifier to operate properly. When an amplifier is running, it develops heat. It is the job of the heatsink to pull this heat away from the internal components. If the heatsink gets too hot, the amplifier will modify its operation to protect itself from damage. The amplifier's ability to maintain a proper operating temperature is oftentimes aggravated by the conditions (ambient air temperature, mounting location, playing level, duration of operation, as well as the load impedance) presented by the auto-sound environment. The Art Series PWM power supply's high-efficiency means lower operating temperatures and a higher tolerance for thermal control. The temperature protection circuit will engage at 75 degrees Celsius.

Heatsink Design

To understand why PPI created this unique heatsink design, it's important to understand what purpose a heatsink serves and how it works.

When an amplifier operates, the internal components develop heat. This heat must be transferred away from the components for them to operate properly. By securing the components to the underside of the heatsink, the process of conduction transfers

the heat from the components to the heatsink. The heatsink, in turn, must dissipate this heat or become too hot for the internal components to operate properly. The heat can be transferred from the heatsink by three different processes: Conduction, Radiation, or Convection.

Conduction is defined as the process by which heat is transferred through matter, without transfer of the matter itself. A practical example of this would be the cooling system in your car which circulates a liquid (matter) in order to transfer the heat away from your engine.

In the mobile environment, conduction is not the primary process of transferring heat from the heatsink. The use of a circulating liquid or gas is impractical, unless specific provisions were made in the design of a heatsink to accommodate this type of transfer. There is nothing in the vehicle which could easily be used to heatsink the heatsink. Air is the only (practical) conductive (heat transfer) medium involved when you install an amplifier in your car. As we will discuss later, heat radiated by the heatsink is conducted out into the environment, triggering the process of convection.

Radiation is defined as the process of giving out light, heat, or other radiant energy. An example of this process would be the sun. It radiates heat, light, and other radiant energy.

Radiation is the primary process of heat transfer for a heatsink. As the conducted heat builds (from the internal components), it radiates from the surface out into the surrounding environment. The amount of heat radiated by the heatsink is determined by its surface area. The traditional way to add surface area is to use fins, expanding the radiating surface without increasing the overall dimensions of the amplifier.

So why doesn't the Art Series heatsink employ the traditional use of fins since it must adhere to the same rules of thermodynamics that all other heatsinks do? We must discuss the third process - convection before the answer will become clear.

Convection is defined as the transfer of heat from one place to another by the movement of heated particles of a gas or liquid. An example of this process would be warming your hand by holding it in the hot air rising from an oven.

When an amplifier's heatsink becomes warm, it conducts heat out into the surrounding environment, warming the air. The warm air begins to rise, creating air currents which draw heat away from the heatsink. With a traditional finned heatsink, this process is most effective when the amplifier is mounted on its vertical axis. As with chimney, the air circulates upward, over the fins, improving the heat transfer process.

Your ability to take advantage of convection is limited by the installation constraints imposed by the mobile environment. Mounting an amplifier on the vertical axis is not always possible and generally, not preferred (by the consumer). The amplifier's heatsink is left with only one primary process for heat transfer - radiation.

Engineers have recognized the importance of radiant surface area, but the constraints of the automotive environment have forced heatsink designs to remain compact. In order to improve radiating efficiency, designers have simply added more fins. With limited space, adding more fins means that they get closer together. What **PPI's** engineers observed was that fins in close proximity radiate heat from fin to fin rather than into the environment. If convection is not available to draw the heat out from between the fins, the heat becomes trapped, causing a reduction in radiant heat transfer efficiency.

The Art Series heatsink addresses this problem and improves radiant heat transfer efficiency by providing more effective radiating surface area. Combined with our highly efficient (less wasted energy in the form of heat) PWM power supply, the result is an amplifier with improved thermal capabilities.

As with any amplifier, care must be taken when selecting a mounting location. There must be two inches of air space around the heatsink for proper heat dissipation to take place. If mounting in an enclosed area, a fan may be added to improve heat transfer. Refer to the Section on Installation for more information.

AM II Protection Circuitry

All Art Series amplifiers utilize a highly-efficient, **Pulse-Width Modulated** power supply. This means the amplifier will continue to operate within regulation until the battery voltage drops below 11 volts or the heatsink temperature reaches 75 degrees Celsius. This new power supply also incorporates the second generation of **PPI's Adaptive MOSFET** protection circuitry.

This advanced protection circuit was developed to prevent shut-off due to the fluctuating impedance loads presented by today's complex speaker systems. The adaptive circuit optimizes output power to maintain uninterrupted operation whenever the amplifier senses an impedance load of less than 2 Ohms. A low impedance indicator (Diagnostic L.E.D.) is provided to let you know when the amplifier is operating in this mode. It is important to note that there is no increase in output power below the 2 Ohm threshold. Maximum power is achieved at 2 Ohms. AM II provides you the satisfaction of knowing that your Art Series amplifier will continue to play when momentary impedance dips occur. (Refer to figure A)

In the case of a short circuit, AM II will engage to protect the shorted channel but will continue to play the unaffected channel. When this occurs, audible distortion will be heard. Turn off the system and repair the short. Once the problem has been repaired, the amplifier will return to normal operation.

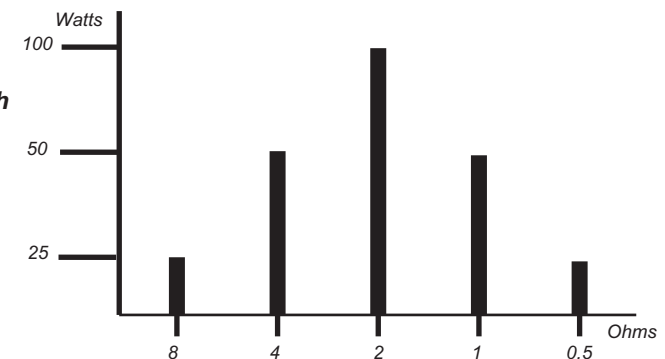

Figure A: AM II Protection Circuitry Output Power vs. Impedance

Exclusive use of discrete output transistors results in increased sonic transparency, outstanding dynamic range, and high-instantaneous current capability. We've designed the power bandwidth to be from 10Hz to 50,000Hz +/- 1dB. This ability to produce full power with linear frequency response well beyond the threshold of human hearing insures that the amplifier's performance over the musical spectrum will be flawless.

The Art Series amplifiers are capable of operation into a two Ohm load in a stereo configuration and a four Ohm load in a bridged mono configuration. However, for optimum performance a four Ohm load in stereo and an eight Ohm load in mono are recommended. Refer to the Section on System Design for more information,

PPI's Exclusive Wire Connection System

Over the years, advances in mobile audio electronics have changed the demands placed on the type and size of wire needed to create a high-performance mobile audio system. To meet this need, **PPI** has created an exclusive wire connection system. This unique, removable connection system offers the versatility of terminal strips, the convenience of quick connect / disconnect style connectors, and the reliability afforded by direct connection to the circuit board. The power and ground connector will accept cable up to 6 gauge in size. The speaker/ remote turn-on connector will accept cables up to 10 gauge in size. Refer to the Section on Installation for more information.

Fusing

The Art Series amplifier is protected from current over-load situations by a blade fuse (Maxi - Fuse). This type of fuse has a number of advantages. First it's available in higher values, and its single element design is more effective than using two fuses of lower value. Second, we could board mount it. This eliminates the use of 'jumperwires' (from the end-panel to the circuit board) which improves reliability. Finally, they are readily available from any auto-supply store and are easy to service. The A204 uses a 20 amp fuse and the A404 and Ax400 use a 30 amp fuse.

For safety reasons, **PPI** recommends that the power cable be fused at the positive terminal of the battery. If this fuse (not-supplied) is not installed, and the power wire shorts to ground (between the battery and the amplifier), a fire can result. The fuse at the battery should be of the same value as the fuse supplied with the amplifier. Consult your Authorized **PPI** Dealer for an appropriate in-line fuse that meets the needs of your installation.

Installation

PRIOR TO INSTALLATION of your new Art Series amplifier it is important to consider the following: In your profession, your abilities and expertise insure a job well done. Trained professional car audio installers are no different. It's their chosen profession, and what they do best. **PPI** believes so strongly in its responsibility to you, that we invest heavily in the hands-on training of professional installers. Our comprehensive system design and installation seminar provides our authorized dealers with the latest techniques to deal with the complexities of car audio today. There is more than meets the eye to ensure that a car stereo reaches its fullest potential. The trained professional, through experience, can approach, recognize, and address all the needs of the mobile audio environment. **PPI** highly recommends that this amplifier and / or any other mobile audio equipment be installed by a trained professional.

Tools / Parts Needed for Installation (not supplied):

Small flat blade screwdriver
Wire cutters
Soldering iron
Flux cleaner
2 - ring connectors
Speaker wire - 16 gauge or larger
Heatshrink Grommets
Silicone or similar material

Phillips screwdriver
Wire strippers
Solder
5 washers, 4 #6 and 1 #8 sheet metal screws
In-line fuse holder and fuse
Power and Ground wire - 12 gauge or larger

Mounting

To prevent damage to the amplifier while driving, mount it in a secure place. Choosing the appropriate location will depend upon your vehicle and the complexity of your system design. It may be mounted in any compatible space that is convenient to your needs and provides sufficient airflow. Adequate ventilation allows the amplifier to dissipate the heat that develops during operation. Inadequate ventilation may result in overheating. The thermal protection circuit will engage when the heatsink temperature reaches 75 degrees Celsius. The amplifier will automatically return to normal operation once the heatsinkcools.

Typical mounting locations include: trunk and passenger compartment (floor or under seat). Never mount the amplifier in a location, which would subject it to immersion or exposure to water.

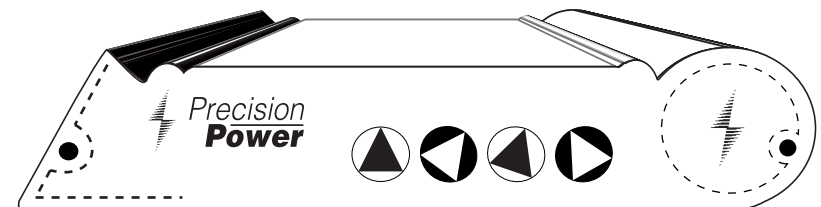

The Art Series' uniquely shaped heatsink is designed for high-efficiency cooling but improper mounting may compromise its ability to cool. When mounting the amplifier in a confined space (i.e. under), care must be taken to ensure that at least two inches of clearance is provided around the amplifier. If the amplifier is located in an area which has restricted air-flow or is totally enclosed, a fan may be used to improve air circulation.

Power and Ground

Before beginning, disconnect the negative (-) terminal of the battery before working on the positive terminal to prevent a short to ground. Reconnect the negative terminal only after all connections have been made.

The Art Series amplifiers are designed to operate from a car's (+) positive 12 volt, negative ground electrical system. The power and ground cables should be 10 gauge for the A404 & Ax400 and 12 gauge for the A204. Depending upon the complexity of your system, larger gauge wire may be needed. PPI's Exclusive Wire Connection System will accept up to 6 gauge cable.

The main power cable should run from the amplifier location, through the vehicle to the battery, avoiding sharp corners, creases, and sharp body parts. When passing through any metal wall (i.e. fire wall etc.), a grommet must be used to prevent the wire from chaffing and shorting to ground. For safety reasons, **PPI** recommends that the power cable be fused at the positive terminal of the battery. If this fuse is not installed, and the power wire shorts to ground (between the battery and the amplifier), a fire can result. The fuse at the battery should be of the same value as the chassis fuse located on the right-hand end panel of the amplifier. Consult your Authorized **PPI** Dealer for an appropriate in-line fuse holder that meets the needs of your installation. We suggest crimping and soldering all wire connections. Insulate the connection with heat shrink to prevent a short to ground.

The ground wire should be of the same gauge as the power wire. As a rule of 'thumb,' use as short a length of wire as possible. Locate an area near the amplifier that is metal (the floor is ideal) and clean an area about the size of a quarter to bare metal. Drill a pilot hole in the middle of this area. Be Careful! Inspect the area under-

neath to be sure you aren't drilling into wires, brake or fuel lines, etc. Terminate the wire with a ring connector and attach it to the bare metal using a # 8 sheet metal screw and washer (not supplied). We suggest crimping and soldering this connection. Insulate the connection with heat shrink. It is important that this connection be solid. After the connection is complete, coat the area with silicone or some similar material to prevent rust from developing.

Once you have run both the power and ground wires, it's time to connect the cable to the amplifier. Be sure that you have not reconnected the ground cable to the negative post of the battery. Cut off excess wire and, using wire strippers, strip the power and ground cables 1 1/4 inch. Locate the power and ground connector (supplied). On the under side of the connector are two slotted screws. With a small flat bladed screw driver, loosen these screws before attempting to insert the cables. After you have inserted the bared end of each cable into the connector, secure it by tightening the associated screw. If inserting larger gauge wire presents a problem, tinning the wire with solder may help. Be sure each connection is tight. Once the wires are secure, the connector may be plugged into the amplifier. Please Note: the power / ground connector is keyed to a slot in the end panel and can only be inserted one way - with the head of the fastening screws pointing down. (Refer to Figure B)

Remote Turn-On

In order for the amplifier to turn on, a remote turn-on wire must be connected to a switched 12 volt source. Typically, the source unit provides a power antenna (remote) turn on lead which will turn on the amplifier when the source unit is activated. If this is unavailable, a switched 12 volt source must be used.

Run a wire from the amplifier location, through the vehicle to the switched 12 Volt source. Observe the same precautions for routing this cable that you followed for running the power cable. Cut off excess wire and, using wire strippers, strip the wire 1 1/4 inch.

Locate the five wire connector which we will refer to as the speaker / remote turn-on connector. On the underside of the connector are five slotted screws. Loosen the middle screw before attempting to insert the remote turn-on lead into the end of the connector. After the wire is inserted, secure it by tightening the associated screw. If inserting larger gauge wire presents a problem, tinning the wire with solder may help. Be sure the connection is tight. You are now ready to connect the speakers. (Refer to Figure C)

Speaker Connection

Run the speaker wires from the amplifier location, through the vehicle to the speakers. Observe the same precautions for routing these wires that you followed for running the power and remote turn-on cables. It is important to use 16 gauge or larger wire, for proper signal transfer. Cut off excess and, using wire strippers, strip 1 1/4 inch. Once again, locate the speaker / remote turn-on connector. Loosen the four remaining screws on the underside of the connector. Insert the speaker leads, one at a time, into the end of the connector. Check to make sure you've maintained proper

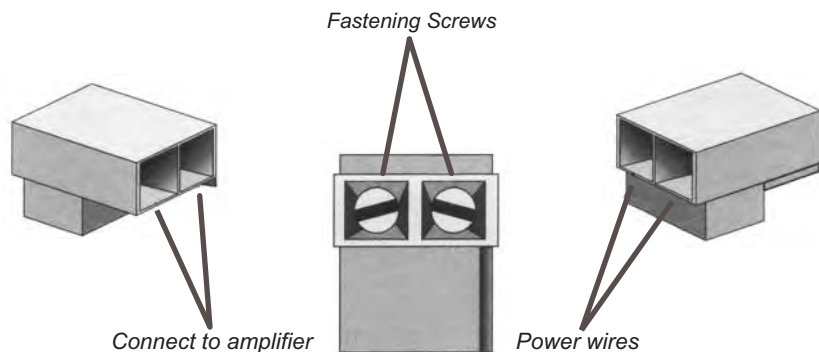

Figure B: Power / Ground Connector

polarity before securing each wire. If inserting larger gauge wire presents a problem, tinning the wire with solder may help. Be sure the connection is tight. The connector may be plugged into the amplifier. (Refer to Figure C)

Bridging

The Front and Rear channels of your (four channel) Art Series amplifier are capable of being bridged into a mono output due to the internal design of the amplifier. This feature permits the creation of a mono channel for a subwoofer or center channel. Also bridging adds flexibility of operation. The Art Series four-channel amplifiers can be used as 2 mono channels, 3 channels - 2 channel stereo and one channel mono, 4 channels - 2 channels front and rear, 5 channels - 4 channels stereo and one channel mono, or 6 channels - 4 channels stereo and 2 channels mono.

Deriving the mono channel is accomplished by using the left channel positive wire as the positive speaker wire and the right channel negative wire as the negative speaker wire. It is important that a minimum 4 Ohm impedance is observed. If the impedance drops below 4 Ohms while the amplifier is wired in the mono configuration, the AM H protection circuit will engage.

The ability to run stereo satellites while simultaneously running a mono output from the same output stage is accomplished simply by running the stereo speakers normally and tapping into the appropriate wires for the "Mixed Mono" channel (left channel positive wire as the positive speaker wire and the right channel negative wire as the negative speaker wire). Again, speaker impedance should be 2 Ohms on the stereo channels and 4 Ohms on the mono channel.

Inputs

On the left side panel of the A204, A404, and Ax400 are 2 sets of RCA-jacks (front and rear). Connect your source unit to these inputs.

On the A204/A404, there is a switch which allows you to parallel the inputs. With the 2/4 way switch in the "in position" the front left input is paralleled with the rear left input and the front right input is paralleled with the rear right input. In this mode, either the front or the rear set of inputs may be used. With the switch in the "out position" all four inputs are utilized and all outputs are separate.

On the Ax400, the internal crossover's setting will determine the function of the four inputs. Depending upon your application, it is important that you refer to the Adjusting the Internal Crossover Section before proceeding. The rear inputs are not active when the crossover is set in the high-pass / low-pass or dual high-pass mode. Refer to the Adjusting the Integrated Crossover Section for more information.

Gain Control

On the left end panel, next to the inputs, is the gain control. This control adjusts the level of the input signal of your source unit. This control requires a small flat blade screwdriver for adjustment. Upon installation of the amplifier, the gain control must be adjusted. This can be done by first turning the gain all the way down (counter clockwise). Turn the volume on the source unit up two thirds. Then adjust the gain control until the desired volume is obtained without audible distortion.

Low Impedance Indicator

AM II circuitry will lower output power to maintain uninterrupted operation whenever the amplifier senses an impedance load of less than 2 Ohms. The Low Impedance Indicator (left-side end panel) is provided to let you know when the amplifier is operating in this mode. It is important to note that there is no increase in output power below the 2 Ohm threshold. Maximum power is achieved at 2 Ohms. In the case of a short circuit, AM II will engage to protect the shorted channel but will continue to play the unaffected channel. When this occurs, audible distortion will be heard. Turn-Off the system and repair the short. Once the problem has been repaired, the amplifier will return to normal operation.

Adjusting the Integrated Crossover (Ax400 only)

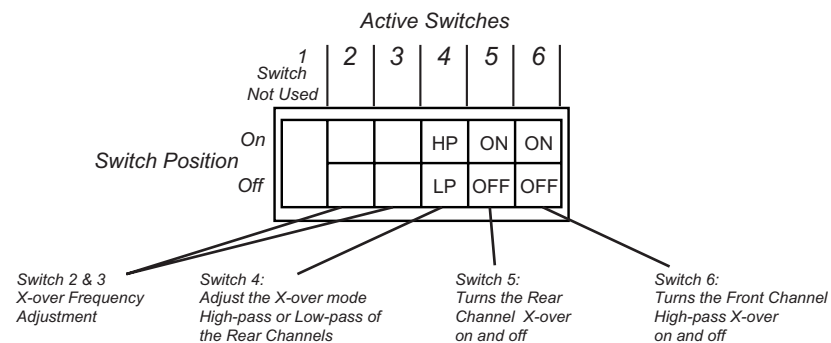

Figure D: Ax400 Integrated Crossover Adjustment Switch

The Ax400 incorporates a two-way, electronic crossover featuring 18 dB per octave slopes and 4 adjustable frequencies - 70 Hz, 110 Hz, 260 Hz, and 300 Hz. The crossover is designed in a tracking configuration and only requires 2 channels of input when engaged.

You can select four different modes of operation - 4 channels full-range, 2 channels high-pass and 2 channels full-range, 2 channels high-pass and 2 channels low-pass, or 4 channels high-pass. Integral to this design is a set of RCA low-pass outputs. These outputs are always available to send a low-pass signal to another amplifier or signal processor.

The four different modes of operation will affect the number of available inputs. The following list details available channels (pairs) of input versus operational mode (Refer to Ax400 Crossover Modes) :

4 Channels full-range:

2 pairs - front and rear

2 Channels high-pass & 2 channels full-range:

2 pairs - front and rear

2 Channels high-pass & 2 channels low-pass:

1 pair - front only

4 Channels high-pass:

1 pair - front only

Switching is controlled via a 6 position dip switch (located through the bottom panel of the amplifier). Five of the six control switches adjust the different functions of the crossover (refer to Figure D. above). The function of each is denoted by its relative 'on / off' position

It is important to note that the low-pass outputs (RCA-jacks) are always available, and the front inputs are their signal source. The position of switch 2 & 3 will determine the frequency available at this output.

Outputs (Ax400 only)

The Ax400's front inputs supply the signal source for a set of RCA low-pass outputs. The frequency of this output signal is determined by the integrated crossover. Switch 2 & 3 of the 6 position dip switch adjusts the low-pass output frequency - 70 Hz, 110 Hz, 260 Hz, and 300 Hz.

System Tuning

In order to achieve maximum signal-to-noise performance from a high quality mobile sound system, it is desirable to use high signal levels wherever possible in the interconnection cables. High signal levels will reduce the effect of induced noise. The peak level of an audio signal is usually determined by the clipping level of electronic components. The following procedure should be used as a guide when the system installation is complete.

Adjusting Crossover Input Gains:

1. Adjust all crossover gain controls to 0 dB, 1/2 of maximum sensitivity.
2. Adjust all amplifier gains to 1/2 of maximum sensitivity.
3. Turn the volume knob on the equalizer to a maximum of 3 o'clock.
4. Increase the gain of the crossover until the onset of audible distortion. Then decrease the gain prior to the immediate point of audible distortion. This setting will minimize system background noise and prevents overloading of the crossover.
5. Repeat step 4 for any remaining crossovers in the system.
6. Adjust the input gains next.

NOTE: In many multi-crossover / accessory systems, the gain of some crossover and accessories may need to be further decreased to achieve proportional balance.

Adjusting the Amplifier's input Gain:

Adjust the amplifier's input gain to 1/2 maximum sensitivity. Turn the volume knob on the equalizer to a maximum of 3 o'clock. Increase the gain (clockwise) until the onset of audible distortion. Then decrease the gain counterclockwise prior to the immediate point of audible distortion. This setting will minimize system background noise and prevents overloading of the amplifier. Repeat step 3 for any remaining amplifiers in the system.

NOTE: Depending on the sensitivity of the systems preamp(s), the gain of the amplifier(s) may not need adjustments. Also, in many multi-amplifier systems, the gain of some amplifiers may need to be further decreased to achieve proportional balance.

TROUBLESHOOTING

If for some reason your system fails to operate properly, please refer to this guide. If you are unable to resolve the problem, consult your Authorized **PPI Dealer** or call **1-800-62-POWER**.

NO SOUND

Is the power LED illuminated?

Check fuses in power wire.

Be sure turn-on lead is connected.

NO SOUND IN ONE CHANNEL

Check speaker leads and inspect for a short to ground or an open connection.

Check pre-amp leads. Reverse left and right leads to see if the problem is before the amplifier.

Check Mono Bridge and Bi-Amp crossover switches on other units prior to the amp.

If the problem is in the amp, have your Dealer inspect the unit.

AMP TURNING OFF

Is the amp able to cool properly?

Check speakers for shorts or damage.

Make sure power and ground are secure.

Have **PPI Dealer** inspect amp.

AX400 CROSSOVER SWITCH SETTINGS

WITH THE CROSSOVER SECTION ENGAGED, THE REAR INPUTS WILL NOT BE USED
 SWITCH NUMBER ONE (1) IS NOT USED AND IS ALWAYS IN THE OFF POSITION

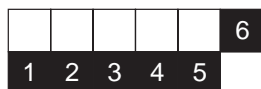
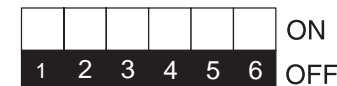
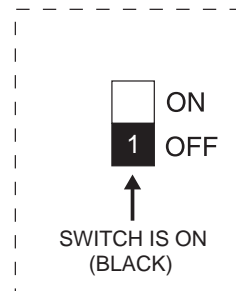

FRONT: HIGHPASS 70Hz
 REAR: FULL RANGE
 (LOWPASS RCA OUT: 70Hz)

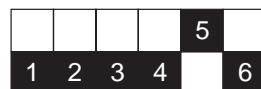

FRONT: FULL RANGE
 REAR: LOWPASS 70Hz
 (LOWPASS RCA OUT: 70Hz)

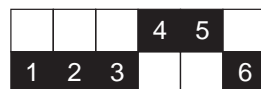

FRONT: FULL RANGE
 REAR: HIGHPASS 70Hz
 (LOWPASS RCA OUT: 70Hz)



FRONT: HIGHPASS 70Hz
 REAR: LOWPASS 70Hz
 (LOWPASS RCA OUT: 70Hz)



FRONT: HIGHPASS 70Hz
 REAR: HIGHPASS 70Hz
 (LOWPASS RCA OUT: 70Hz)



FRONT: HIGHPASS 110Hz
 REAR: FULL RANGE
 (LOWPASS RCA OUT: 110Hz)



FRONT: FULL RANGE
 REAR: LOWPASS 110Hz
 (LOWPASS RCA OUT: 110Hz)



FRONT: FULL RANGE
 REAR: HIGHPASS 110Hz
 (LOWPASS RCA OUT: 110Hz)



FRONT: HIGHPASS 110Hz
 REAR: LOWPASS 110Hz
 (LOWPASS RCA OUT: 110Hz)



FRONT: HIGHPASS 110Hz
 REAR: HIGHPASS 110Hz
 (LOWPASS RCA OUT: 110Hz)



FRONT: HIGHPASS 260Hz
 REAR: FULL RANGE
 (LOWPASS RCA OUT: 260Hz)



FRONT: FULL RANGE
 REAR: LOWPASS 260Hz
 (LOWPASS RCA OUT: 260Hz)



FRONT: FULL RANGE
 REAR: HIGHPASS 260Hz
 (LOWPASS RCA OUT: 260Hz)



FRONT: HIGHPASS 260Hz
 REAR: LOWPASS 260Hz
 (LOWPASS RCA OUT: 260Hz)



FRONT: HIGHPASS 260Hz
 REAR: HIGHPASS 260Hz
 (LOWPASS RCA OUT: 260Hz)



FRONT: HIGHPASS 300Hz
 REAR: FULL RANGE
 (LOWPASS RCA OUT: 300Hz)



FRONT: FULL RANGE
 REAR: LOWPASS 300Hz
 (LOWPASS RCA OUT: 300Hz)



FRONT: FULL RANGE
 REAR: HIGHPASS 300Hz
 (LOWPASS RCA OUT: 300Hz)



FRONT: HIGHPASS 300Hz
 REAR: LOWPASS 300Hz
 (LOWPASS RCA OUT: 300Hz)

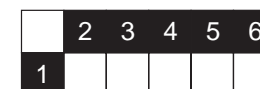

FRONT: HIGHPASS 300Hz
 REAR: HIGHPASS 300Hz
 (LOWPASS RCA OUT: 300Hz)