



Thank you for choosing *PPI* audio equipment. Now, **HANG ON!** *PPI* products are engineered and manufactured to deliver a wild ride of performance, sound quality, and reliability. This *PPI* product reflects our commitment to offer you versatility and quality for years of incredible power and listening enjoyment!

SERVICE

Do not attempt to service *PPI* products yourself. Performing exploratory surgery on your audio equipment yourself will void the warranty. All parts of your *PPI* gear have been built to our specifications. These parts are not made available to any unauthorized *PPI* dealer nor are they for sale. Our goal is to make sure that your *PPI* product will always perform as good as the day it was purchased. Contact your authorized *PPI* dealer about obtaining any warranty service through *PPI*. (See Warranty inside back cover.)

CAUTION!

The extended use of a high powered audio system may result in hearing loss or damage. While *PPI* systems are capable of "Concert Level" volumes, they are also designed for you to enjoy at more reasonable levels all of the creative expressions made by musicians. Please stay seated while driving and observe all local sound ordinances.

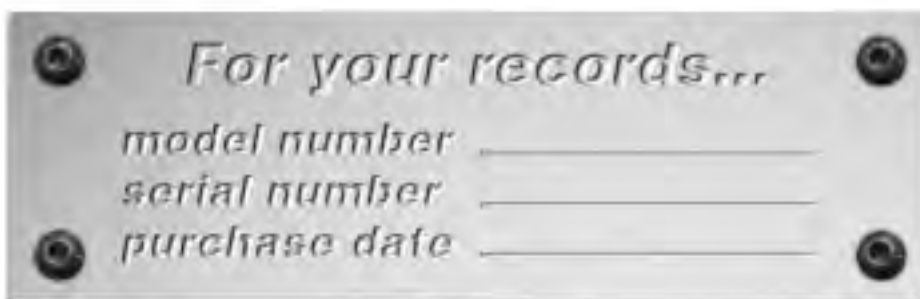

Features

- 4-Way/5-Way Variable Crossover with RCA Outputs
- QBASS™ Bass Boost
- Balanced Differential Input Circuit
- Speaker Lead High Level Inputs
- High Voltage Input Capability
- Gold Plated RCA, Speaker and Power Connectors
- Mixed Mono/Stereo Operation

Specifications

- Power Bandwidth: 7Hz to 80kHz
- Signal to Noise Ratio: 105 dB
- Total Harmonic Distortion:05%
- Input Sensitivity: 100mV to 12V
- Input Impedance: 10k Ohms
- Load Impedance (Stereo): . . . 2 Ohms to 8 Ohms
- Load Impedance (Bridge): . . . 4 Ohms to 8 Ohms
- Supply Voltage: 10V to 15V
- Damping Factor: >300
- Slew Rate: >45V/μs
- QBASS™ Equalization: Up to +12db Boost @ 40Hz

Dimensions

- PPI4240 L: 285mm/11.22"
W: 256mm/10.08"
H: 62mm/2.44"
- PPI5440 L: 435mm/17.12"
W: 256mm/10.08"
H: 62mm/2.44"

Continuous Power Output

- *PPI4240* 30W x 4 Channels @ 4 Ohms
60W x 4 Channels @ 2 Ohms
120W x 2 Channels @ 4 Ohms Bridged
- *PPI5440* 30W x 4 Channels @ 4 Ohms
+ 120W x 1 Channel @ 4 Ohms
60W x 4 Channels @ 2 Ohms
+ 200W x 1 Channel @ 2 Ohms
120W x 2 Channels @ 4 Ohms Bridged
+ 120W x 1 Channel @ 4 Ohms

Crossover Settings

- *PPI4240* Front Variable 12db/Octave FULL/HPF/LPF 20-5kHz
Rear Variable 12db/Octave FULL/HPF/LPF 20-5kHz
Selectable FULL/HPF/LPF RCA Output
- *PPI5440* Front Variable 12db/Octave FULL/HPF/LPF 20-5kHz
Rear Variable 12db/Octave FULL/HPF/LPF 20-5kHz
Sub Variable 12db/Octave FULL/HPF/LPF 20-500Hz

Fuse Requirements

- *PPI4240* Maximum Fuse Rating: 40 Amp (20 x 2)
- *PPI5440* Maximum Fuse Rating: 60 Amp (30 x 2)

Wiring

The following formula is a guide to determine current draw so you can choose the proper gauge power cable and fuses for your system. A 50% amplifier efficiency rating is used as an average.

$$\text{(Total 4-Ohm rate RMS output x 2) x 2 = Total Input Wattage}$$

$$\text{Total Input Wattage/Supply Voltage = Current Draw (in Amps)}$$

Example: Your PPI4240 is 30 watts x 4 RMS @ 4-Ohms.
 You would use the formula below:
 $30 \times 4 = 120$ watts Total Output
 $120W \times 2 = 240W$ Input/ $12.5v = 19.2$ amps Current Draw

Note: Notice that the total power is multiplied by two. This compensates for the 50% efficiency of the amplifier. When you drop your impedance in half you double the amperage.

Recommended Minimum Gauge

Total Current Draw (in Amps)	Length of Wire to Run (in Feet)							
	<3	<7	<10	<13	<17	<20	<22	<28
0 - 20	14	12	12	10	10	8	8	8
20 - 35	12	10	8	8	6	6	8	4
35 - 50	10	8	8	6	6	4	4	4
50 - 65	8	8	6	4	4	4	4	2
65 - 85	6	6	4	4	2	2	2	0
85 - 105	6	6	4	2	2	2	2	0
105 - 125	4	4	4	2	2	0	0	0
125 - 150	2	2	2	2	0	0	0	0

Note: The ground wire should be the same size as the power wire.

Wiring

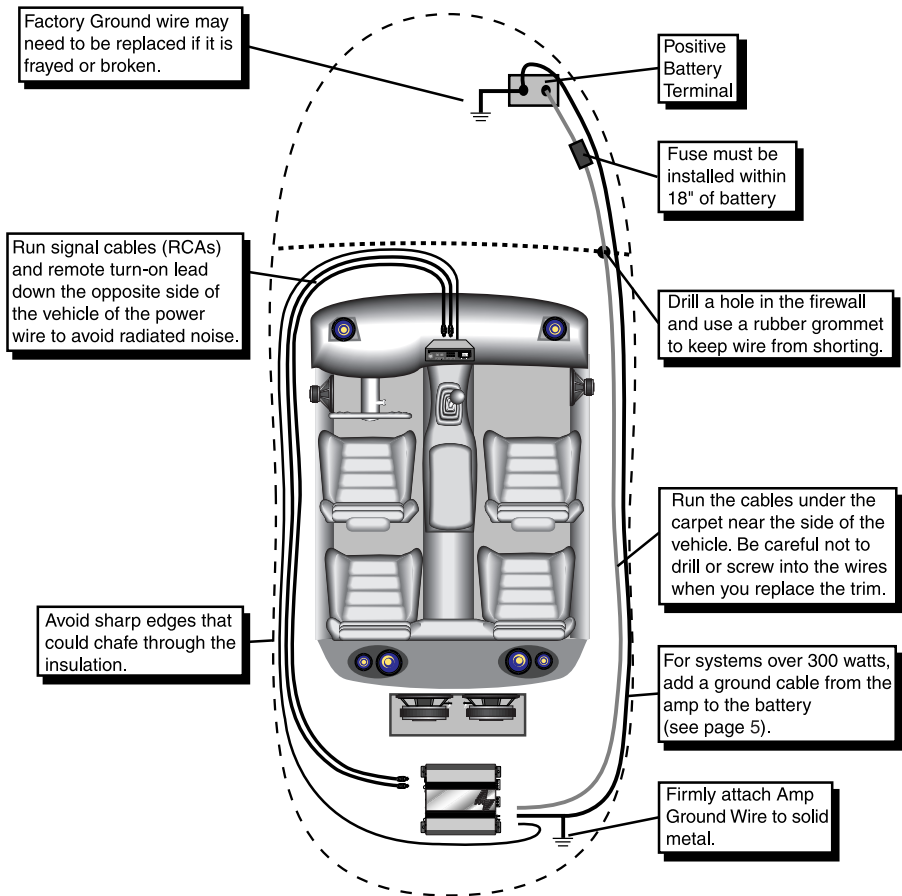

- *Before beginning, disconnect the negative (-) terminal of the battery prior to working on the positive (+) terminal to prevent a short to ground. This is important, unless you want to spend the rest of your life with a nickname like "Sparky," or "Smokey." Reconnect the negative terminal only after all connections have been made.*
- *You will need to install an in-line fuse or circuit breaker in the power wire within 18" of the battery. This fuse or circuit breaker protects your vehicle from fire in case the power wire shorts to the vehicle body.*



Remote Turn-on

Your head unit should have a lead marked 'remote' or 'power antenna' which will be used to turn on your amplifier. Extend this lead through your vehicle along with your RCA signal wires. Strip 1/4 inch of the insulation off the wire and insert the end into the corresponding terminal on the amplifier.

Grounding

Locate an area near the amplifier(s) that is metal and clean an area about the size of a quarter to bare metal. Inspect the area around and underneath to be sure you won't drill into wires, brake or fuel lines, etc. Drill a pilot hole in the middle of this area. Terminate the ground wire with a ring connector and attach it to the bare metal using a #8 sheet metal screw and washer or preferably, a bolt, nut and a star washer (not supplied). We suggest crimping and soldering this connection. After the connection is complete, coat the area (on both sides) with silicone or some similar material to prevent rust from developing on the bare metal.

If your grand total current draw is over 50 amps (or total output power is over 300 watts), you should run a ground wire beside your power wire from the battery to the amplifier(s) in addition to your regular ground wire. Keep the ground and power wires as close together as possible, and use the same gauge wire for both. This will ensure that you have a good ground path, and may eliminate such potential problems as engine noise and overheated amplifiers.

Once you have run both the power and ground wires, it's time to connect the cables to the amplifier. Cut off excess wire and, using wire strippers, strip the ends of the power and ground cables approximately 1/4 inch. Locate the power and ground connectors on the amplifier. With a small phillips head screw driver, loosen the screws before to you insert the cables. Insert the wires into the appropriate hole, and tighten the screws. The Power/Ground/Remote will accommodate 8 gauge wire for the *PPI4240* and the *PPI5440*.

Speaker Wires

Using 16 gauge or larger, run the speaker wires from the amplifier location through the vehicle to the speakers. Observe the same precautions for routing these wires that you followed for running the power and remote turn-on wires. Cut off excess and, using wire strippers, strip 1/4 inch of insulation. Loosen the four outer screws on the top of the connector. Insert the speaker leads into the end. Check to be sure you've maintained proper polarity before securing each wire, and tighten the screws on the amplifier.

Endplate Diagram

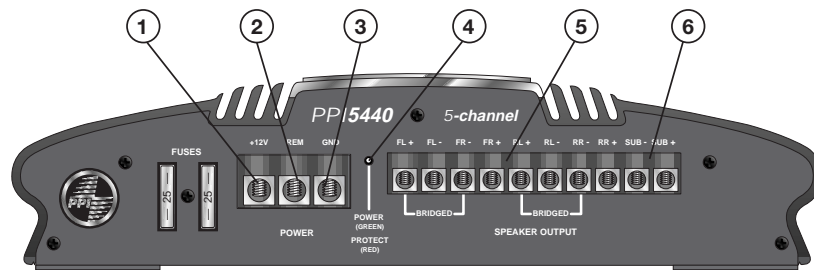
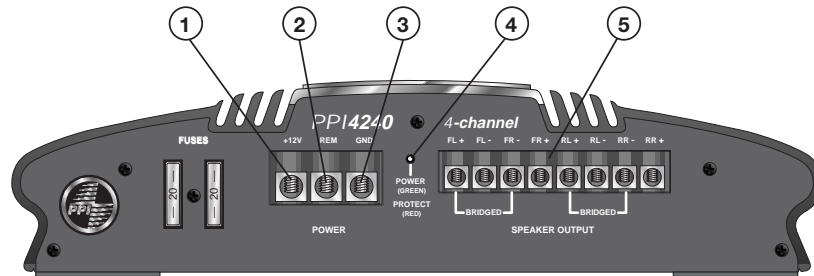

1. **Battery Power**
Connect the 12-volt constant power cable from the battery here.
2. **Remote**
Connect the remote turn on lead from you source unit here. This connection will turn the amplifier on when the source unit is powered up.
3. **Ground**
Connect your ground wire here. Make sure you use the same gauge wire as your power cable.
4. **Power LED**
The LED will light up "GREEN" when the amplifier is powered on and "RED" when it goes into protection.
5. **Speaker Terminals**
Insert your speaker cable here. Insert speaker wire into LEFT (+) and RIGHT (-) for bridging.
6. **Subwoofer Speaker Terminals**
Insert the speaker cable for your subwoofer here.

Bridging

All *PPI* amplifiers are capable of being bridged into a 4-Ohm mono output without switches or bridging modules. This in turn allows you to run Full range or component speakers and a subwoofer off one *PPI* amplifier. (using passive crossovers)

You can achieve this mono channel by using the Left positive (+) speaker connection and Right negative (-) speaker connection. You can bridge channels 3 and 4, on your *PPI* four channel amplifiers, in the same way. (Refer to the end panel drawing on page 8.)

Mixed Mono Wiring

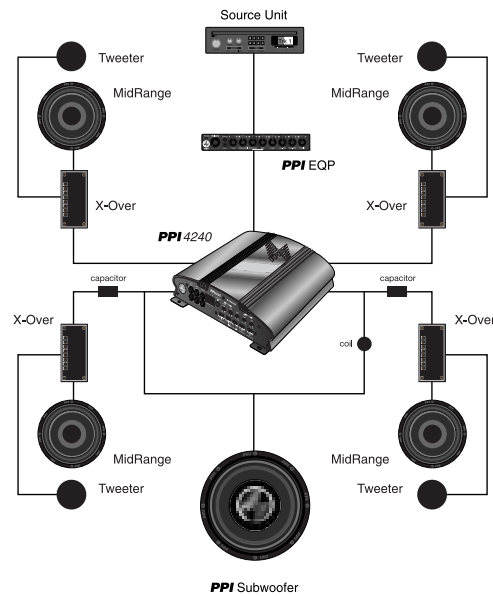

Your new *PPI* amplifier offers you the flexibility of mixed mono operation. This means you can operate each pair of channels in both stereo and mono mode at the same time. This is accomplished by using highpass filters (capacitors) on the higher frequency stereo channels, and a lowpass filter (coil) on the subwoofers. The frequencies of the chosen highpass and lowpass filters must not overlap (allow the mids and highs to play the same music as the subs) or the impedance the amplifier sees at those frequencies will be cut in half possibly causing it to go into protection.

Endplate Diagram

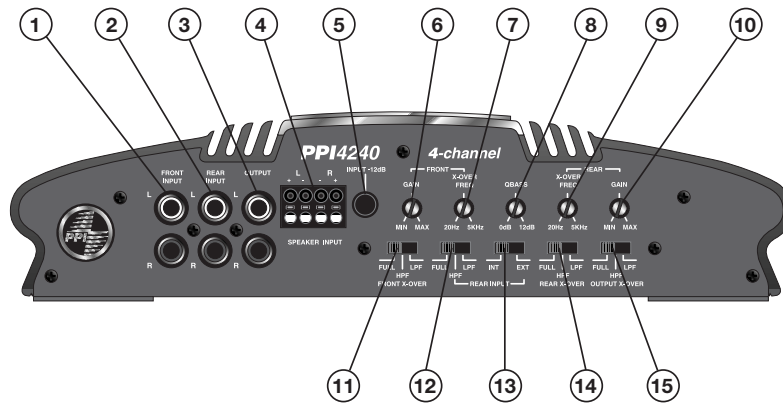

1. **Front RCA Input**
Plug in the front RCA cables from the source unit or *PPI* signal processor here.
2. **Rear RCA Input**
Plug in the rear RCA cables from the source unit or *PPI* signal processor here.
3. **RCA Outputs**
Plug in the RCA cables here to send signal to a second amplifier. This output can be Full Range, High Pass or Low Pass according to the Output X-Over Switch.
4. **Speaker Input**
Plug in speaker cables here when RCA cables are not available.
5. **Input -12db**
Push this switch "IN" when using Speaker Inputs, or when RCA level is over 5V.
6. **Front Gain Control**
Use this control to match the output level of the head unit to the amplifier.
7. **Front X-Over Freq**
Select the front crossover frequency here. The detented control moves clockwise from 20Hz to 5kHz. Use the chart on page 20 to select the desired crossover frequency.
8. **QBASS™ Control**
Select the desired boost for both Front and Rear Channels by turning

PPI4240 Endplate

9. **Rear X-Over Freq**
Select the rear crossover frequency here. The detented control moves clockwise from 20Hz to 5kHz. Use the chart on page 20 to select the desired crossover frequency.
10. **Rear Gain Control**
Use this control to match the output level of the head unit to the amplifier.
11. **Front X-Over Switch**
Select the desired crossover setting, FULL/HPF/LPF for the front speaker outputs.
12. **Rear Input X-Over Switch**
Select the desired crossover setting, FULL/HPF/LPF for the input signal to the rear channel when using internal signal path vs. RCA input.
13. **Rear Input Internal/External Switch**
Select "INT" position if you want to use the internal signal path from the front crossover for the rear input, or the "EXT" position to use the external rear RCA input.
14. **Rear X-Over Input Switch**
Select the desired crossover setting FULL/HPF/LPF for the rear speaker output.
15. **Output X-Over Switch**
Select the desired crossover setting, FULL/HPF/LPF for the RCA



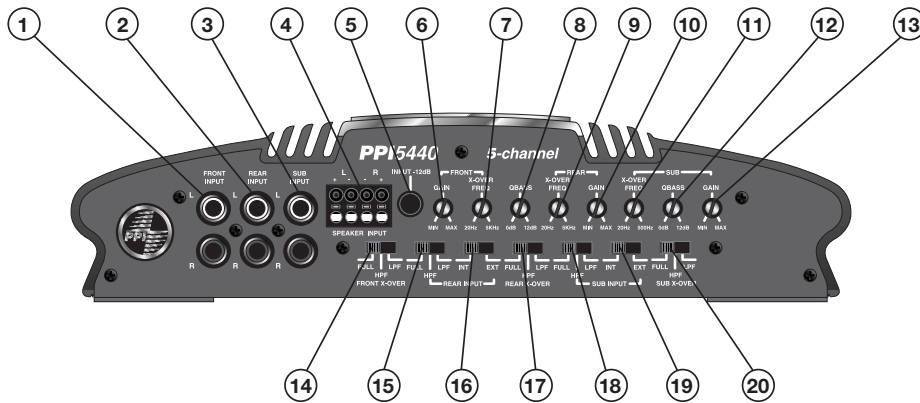

1. **Front RCA Input**
Plug in the front RCA cables from the source unit or *PPI* signal processor here.
2. **Rear RCA Input**
Plug in the rear RCA cables from the source unit or *PPI* signal processor here.
3. **Subwoofer RCA Input**
Plug in the subwoofer RCA cables from the source unit or *PPI* signal processor here.
4. **Speaker Input**
Plug in speaker cables here when RCA cables are not available.
5. **Input -12db**
Push this switch "IN" when using Speaker Inputs, or when RCA level is over 5V.
6. **Front Gain Control**
Use this control to match the output level of the head unit to the amplifier.
7. **Front X-Over Freq**
Select the front crossover frequency here. The detented control moves clockwise from 20Hz to 5kHz.
8. **QBASS™ Control**
Select the desired boost for both Front and Rear Channels by turning the control clockwise from 0-12dB.



9. **Rear X-Over Freq**
Select the rear crossover frequency here. The detented control moves clockwise from 20Hz to 5kHz.
10. **Rear Gain Control**
Use this control to match the output level of the head unit to the amplifier.
11. **Subwoofer X-Over Freq**
Select the subwoofer crossover frequency here. The detented control moves clockwise from 20Hz to 500Hz.
12. **Subwoofer QBASS™ Control**
Select the desired boost by turning the dial clockwise from 0-12dB centered at 40Hz on the rear channel.
13. **Subwoofer Gain Control**
Use this control to match the output level of the head unit to the amplifier.
14. **Front X-Over Switch**
Select the desired crossover setting, FULL/HPF/LPF for the front speaker outputs.
15. **Rear Input X-Over Switch**
Select the desired crossover setting, FULL/HPF/LPF for the input signal to the rear channel when using internal signal path vs. RCA input.
16. **Rear Input Internal/External Switch**
Select "INT" position if you want to use the internal signal path from the front crossover for the rear input, or the "EXT" position to use the rear RCA input.
17. **Rear X-Over Switch**
Select the desired crossover setting FULL/HPF/LPF for the rear speaker output.
18. **Sub Input X-Over Switch**
Select the desired crossover setting, FULL/HPF/LPF for the output signal of the rear channel when using internal signal path vs. RCA input.
19. **Sub Input Internal/External Switch**
Select "INT" position if you want to use the internal signal path from the rear crossover for the sub input, or the "EXT" position to use the external sub RCA input.
20. **Sub X-Over Switch**
Select the desired crossover setting, FULL/HPF/LPF for the RCA output.

System Adjustments

1. Adjust all amplifier input gain controls to just above minimum sensitivity (fully counterclockwise).
2. Using the cleanest source (CD), with music playing turn up the head unit until you can hear the music begin to distort. Now turn it down a bit until you cannot hear the distortion.
3. Increase the Amplifier gain (clockwise) until the onset of audible distortion. Then decrease the gain to the point just before the distortion starts. This setting minimizes background noise and prevents overload.
4. Repeat step 3 for any remaining amplifiers in the system.

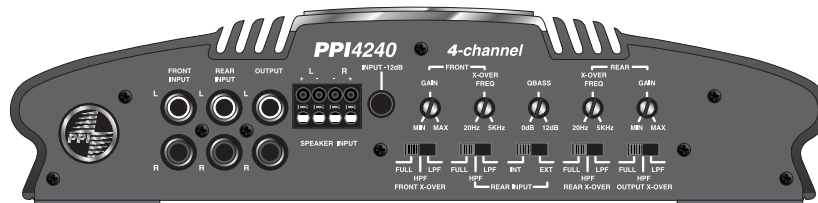

Crossover Settings

Your new *PPI* amplifier has one two-way built-in crossover. By using the 'X-OVER' switch on your amplifiers endplate, you are able to select either full range, high pass or low pass (FULL/HPF/LPF) for your 'Speaker Output'. Using the 'X-OVER FREQ' control select the desired crossover frequency, 20Hz to 5kHz. Now it's time to set the 'OUTPUT X-OVER' as FULL/HPF/LPF. The 'OUTPUT' will be whatever frequency you selected on the 'X-OVER FREQ' and either FULL/HPF/LPF depending on where you set the 'OUTPUT X-OVER'.



For extra BOOM from your system, we've developed the *QBASS™* bass control circuit. The *QBASS™* control is located to the left of the crossover switches and allows you to add up to 12dB of boost centered at 40Hz by rotating the control clockwise.

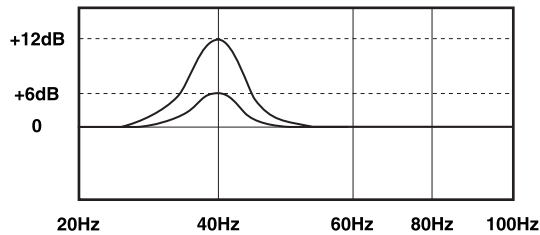

CAUTION! *QBASS™* should only be used in systems with strong subwoofers. 12dB is a lot of bass boost and could damage full range speakers.

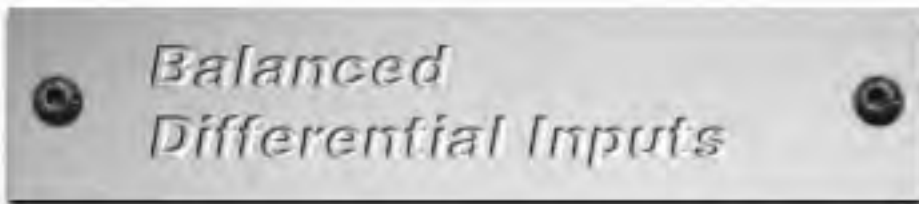

This circuitry is capable of eliminating noise radiated into your signal cables by up to 40dB. This is equivalent to a noise reduction of approximately one hundred times what the noise level would be without this circuitry. It provides all the benefits of a true 'balanced' line without the need of any special cables (see diagram below). This type of input works with any conventional RCA cable.

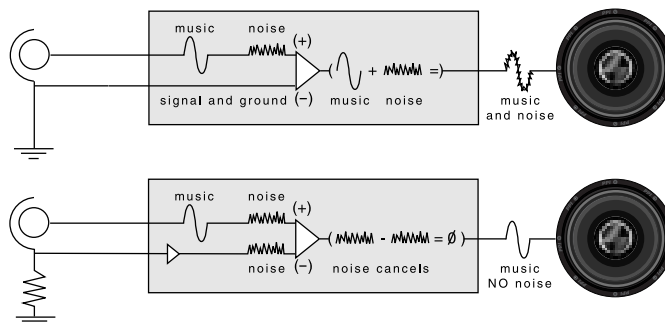

Troubleshooting

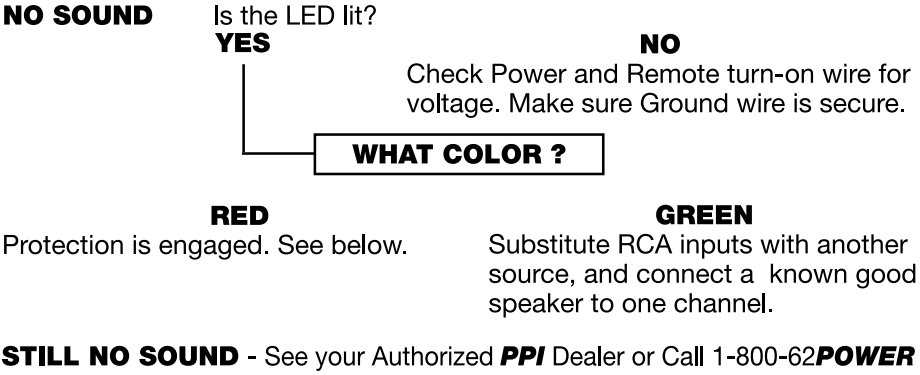

SOUND IN ONE CHANNEL ONLY
Reverse left and right speaker connections.

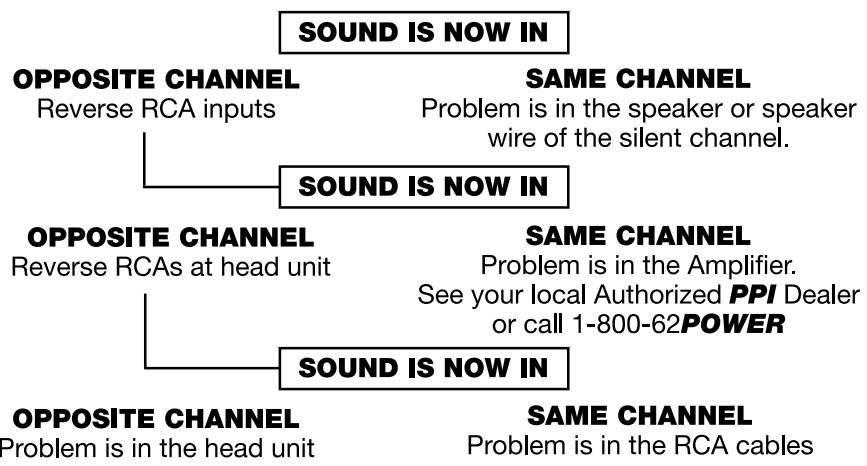

AMPLIFIER SHUTS OFF

Short Circuit Protection engaged: The amplifier will turn off and try to come back on immediately. The amplifier will cycle like this indefinitely, with "blips" of sound each time. If this is the case, check your speakers and wiring for low impedance and short circuits.

Thermal Protection engaged: The amplifier will turn off and several minutes later will come back on. In this case, ensure that there is nothing blocking the normal convective airflow of the amplifier. No obstruction should be within 2" of the amplifier on all sides.

System Diagram

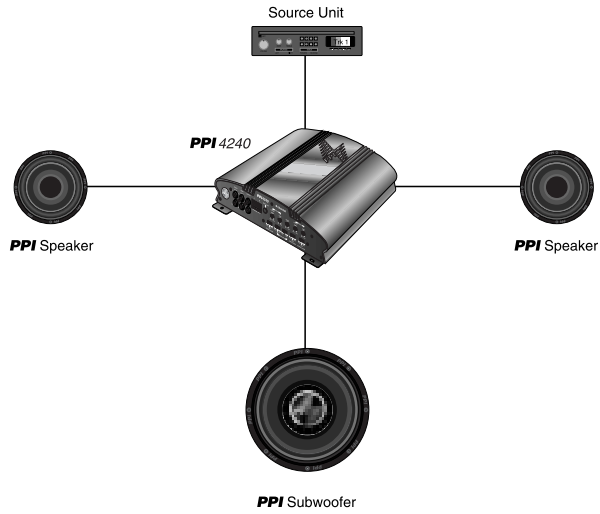

System One

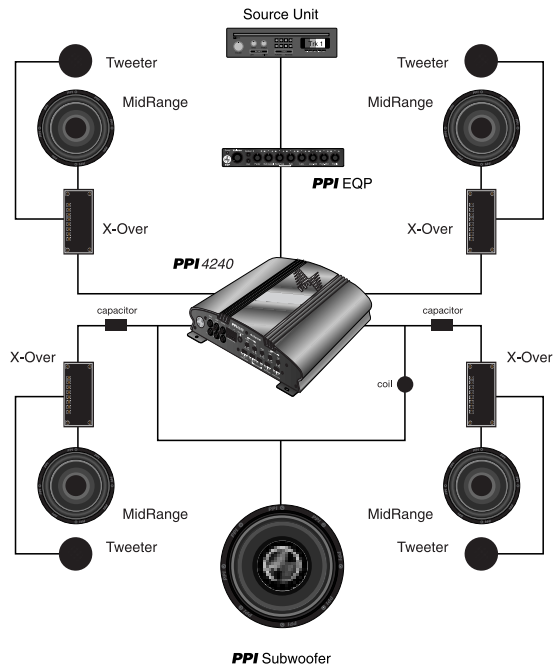

System Two

System Diagram

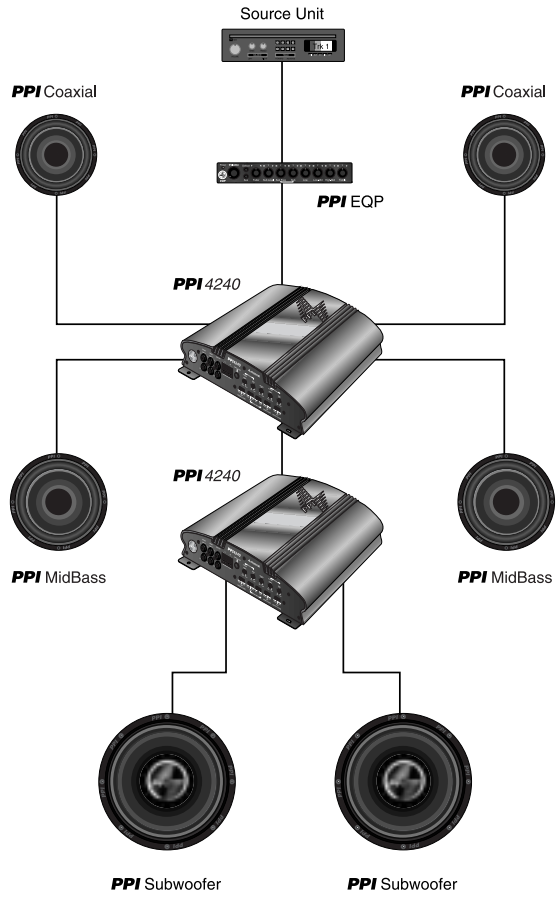

System Three

System Diagram

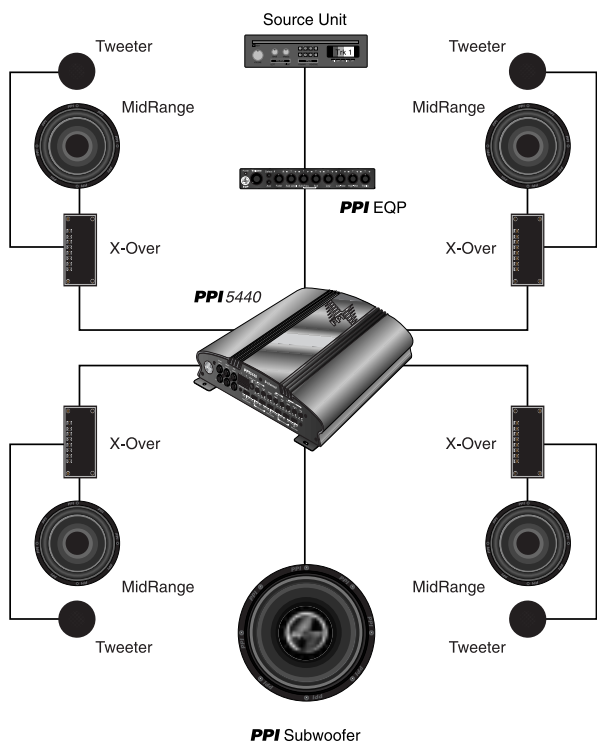

System Four

Block Diagram

PPI4240

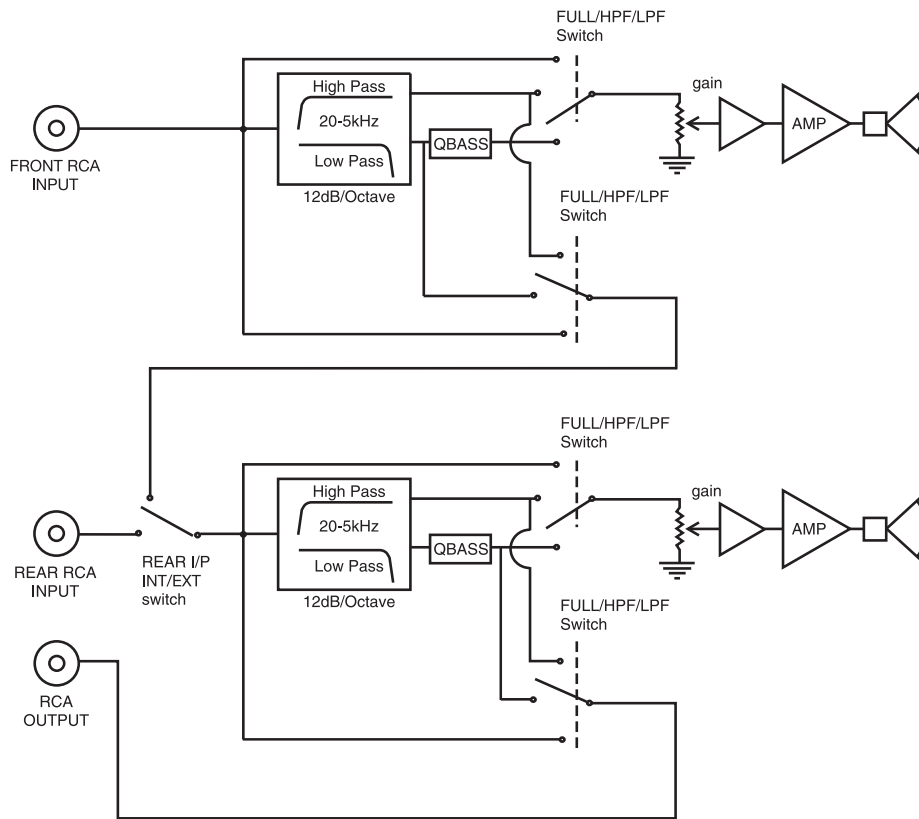

Block Diagram

PPI5440

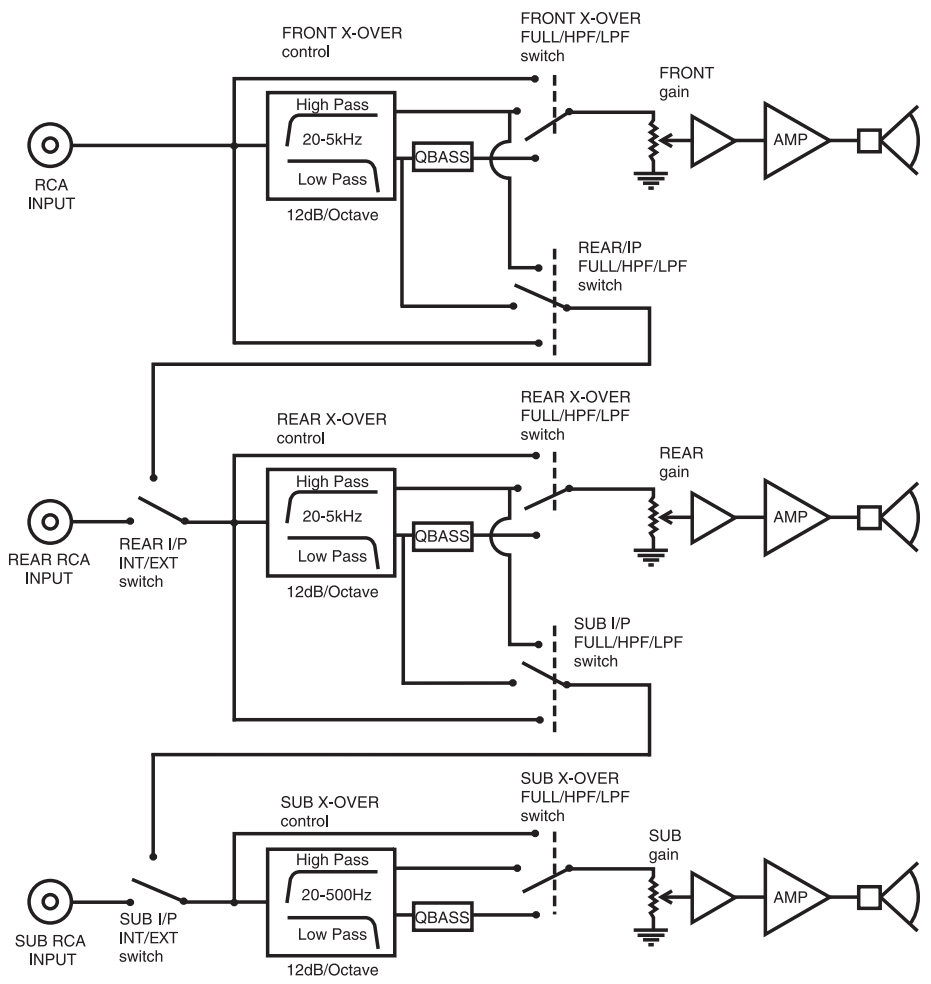

Frequency Charts

Consistent with PPI's commitment to continuous product improvements, changes have been made to the crossover section of your new PPI amplifier. The controls are now detented for improved performance. Each "click" counted from the full counterclockwise position corresponds to a specific frequency. Refer to this chart for set up instructions.

Front and rear channels		Subwoofer channels	
DETENT	XOVER FREQ	DETENT	XOVER FREQ
1	20 Hz	1	18 Hz
2	21 Hz	2	18 Hz
3	21 Hz	3	18 Hz
4	21.5 Hz	4	18 Hz
5	22 Hz	5	20 Hz
6	23 Hz	6	21 Hz
7	24.5 Hz	7	22 Hz
8	26 Hz	8	24 Hz
9	27.5 Hz	9	25 Hz
10	30 Hz	10	26 Hz
11	32 Hz	11	29 Hz
12	35 Hz	12	32 Hz
13	39 Hz	13	36 Hz
14	43 Hz	14	40 Hz
15	49 Hz	15	44 Hz
16	56 Hz	16	50 Hz
17	64 Hz	17	58 Hz
18	73 Hz	18	66 Hz
19	80 Hz	19	72 Hz
20	88 Hz	20	80 Hz
21	100 Hz	21	88 Hz
22	114 Hz	22	100 Hz
23	134 Hz	23	113 Hz
24	160 Hz	24	132 Hz
25	196 Hz	25	158 Hz
26	260 Hz	26	188 Hz
27	320 Hz	27	210 Hz
28	368 Hz	28	222 Hz
29	432 Hz	29	240 Hz
30	496 Hz	30	268 Hz
31	608 Hz	31	295 Hz
32	752 Hz	32	316 Hz
33	864 Hz	33	334 Hz
34	1008 Hz	34	354 Hz
35	1200 Hz	35	374 Hz
36	1488 Hz	36	400 Hz
37	1952 Hz	37	430 Hz
38	2816 Hz	38	460 Hz
39	4512 Hz	39	480 Hz
40	4944 Hz	40	487 Hz
41	5000 Hz	41	495 Hz

3-Year Limited U.S.A. Warranty

This warranty gives you specific legal rights, and you may also have other rights which vary from state to state. PrecisionPower, Inc. (PPI) warrants its products to be free from defects in materials and workmanship under normal use and service for a period of three (3) years from the date of original purchase when the unit is installed by an Authorized Dealer. Non-Authorized Dealer installed products carry a one (1) year parts and ninety (90) days labor limited warranty. The extent and conditions of Limited Warranty are as follows:

1. Authorized Dealer Installed Products: PPI will either repair or replace at no charge, to the original purchaser, any unit which PPI's examination discloses to be defective and under warranty, provided the defect occurs within three (3) years from the date of original purchase when the unit is installed by an Authorized Dealer and the product is returned immediately to PPI. This warranty is not transferable.
2. Non-Authorized Dealer Installed Products: PPI will either repair or replace at no charge, to the original purchaser, any unit which PPI's examination discloses to be defective and under warranty, provided the defect occurs within ninety (90) days from the date of purchase and the product is returned immediately to PPI. Warranty claims beyond ninety (90) days for Non-Authorized Dealer Installed Products will be for parts only and will extend for one (1) year from the date of purchase. This warranty is not transferable.
3. The date of purchase and proof of Authorized Dealer Installation of a PPI product must be established by an original sales receipt which must accompany the article being returned for warranty work.
4. This warranty shall NOT apply to any PPI product found to have the original factory serial number removed or defaced. All products received (by PPI) for in warranty or out of warranty repair, with their original serial numbers removed or defaced, will NOT be repaired and will be returned to sender, freight collect. Refer to original packaging for the serial number of your component speakers.
5. The provisions of this warranty shall not apply to any PPI product used for a purpose for which it is not designed, which has been repaired or altered in any way, or which has been connected, installed, or adjusted other than in accordance with the instructions furnished in PPI's owner's manual. Nor shall this warranty apply to any part which has been subject to misuse, neglect, or accident.
6. PPI does not authorize any other persons to assume any other liability in connection with its products. THIS WARRANTY IS THE ONLY EXPRESS WARRANTY MADE BY PRECISIONPOWER APPLICABLE TO ITS PRODUCTS. ANY IMPLIED WARRANTY OR MERCHANTABILITY OR FITNESS FOR A PARTICULAR PURPOSE APPLICABLE TO PRECISIONPOWER PRODUCTS IS LIMITED IN DURATION TO THE DURATION OF THIS LIMITED WARRANTY. PRECISIONPOWER SHALL NOT BE LIABLE FOR THE INCIDENTAL, CONSEQUENTIAL, OR COMMERCIAL DAMAGES RESULTING FROM THE BREACH OF THIS WRITTEN WARRANTY. Some states or provinces do not allow the exclusion or limitation of incidental or consequential damages or limitations on how long an implied warranty lasts; so the above limitations or exclusions may not apply to you.
7. Your product will be serviced on an in-warranty basis within the warranty period for the correction of warranted defects. If improper operation of your PPI product should occur, contact your Authorized Dealer for assistance with the return and factory repair of your PPI product. If an Authorized Dealer is not available, return the unit including your name, telephone number, return address, a copy of your sales receipt, and a description of the problem to:

PrecisionPower, Inc.
Service Department
4829 S. 38th Street
Phoenix, AZ 85040-2964

TO RETURN PPI PRODUCTS OUT OF WARRANTY: Return the unit, postage prepaid, in the original protective carton. Please include a description of the problem and, if desired, a request for an estimate of repair costs. Unless a request for an estimate is included, the unit will be repaired as necessary. Please contact PPI Customer Service at 1-800-62-POWER for questions concerning out of warranty repair charges. Repaired unit will be returned with an itemized statement, C.O.D.